

Poltroncina rivestita con scocca in poliuretano e base girevole 5 razze "Classic" in alluminio verniciato con alzata a gas

Upholstered armchair with polyurethane shell and 5 star swivel "Classic" base in varnished aluminum with gas lift

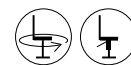
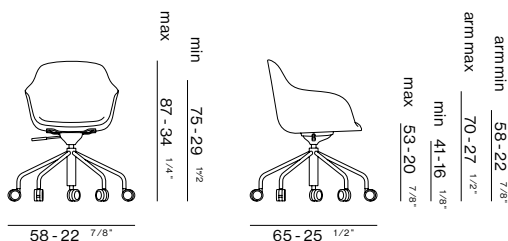

OMOLOGAZIONE MINISTERIALE
1. IM CON TESSUTO MINIBY FIDIVI
PER RIVESTITA TOTALE

- Ruote Ø 65 mm in copolimero rinforzato e fasce di rotolamento morbide**
Ø 65 mm reinforced copolymer castors with soft rolling treads
- Base a cinque razze in acciaio tubo Ø 20 mm al carbonio ad alto spessore. Alta percentuale (max 60,8%) di materiale ferroso riciclato (LEED - NC 2009). Telaio verniciato a polveri termoindurenti a base di resine poliestere per la prevenzione della proliferazione microbica**
Five-star steel base with 20 mm thick carbon tube. High percentage (max 60,8%) of recycled ferrous material (LEED - NC 2009) powder coated. Thermosetting powder-coated frame based on polyester resins to prevent microbial proliferation
- Pistone a gas**
Gas lift
- Meccanismo oscillante con piastra di fissaggio (angolo di oscillazione 7° indietro 4° avanti) e regolazione in altezza tramite leva**
Swing mechanism with fixing plate (swing angle 7° backwards 4° forwards) and height adjustment via lever
- Scocca in poliuretano flessibile stampato a freddo. Inserto strutturale in metallo. Densità 63 kg/m³**
Cold-formed flexible polyurethane shell. Structural metal insert. Density 63 kg/m³

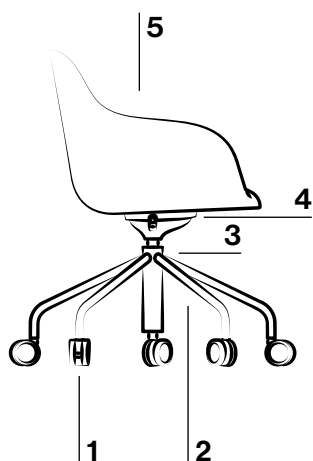

FINITURE FINISHES

STRUTTURA FRAME

Verniciato a polvere Powder coated

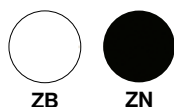

DETTAGLI SPEDIZIONE SHIPMENT DETAILS

1	1pz	0,4 m ³	11,5 kg

VERSIONE SCOCCA SHELL VERSION

Rivestita totale

Fully upholstered

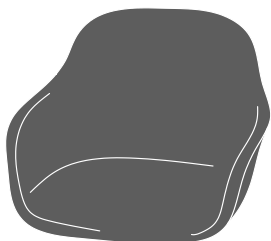

Tessuto cliente: necessaria approvazione di m | artedesign
Fabric supplied by customers: must be approved by m | artedesign



Omolgazione ministeriale 1. IM con tessuto Mini by Fidivi
Ministerial approval 1. IM with Mini by Fidivi fabric



1,7 ml



2,4 mq

Rivestita "Super Soft"

Upholstered "Super Soft"

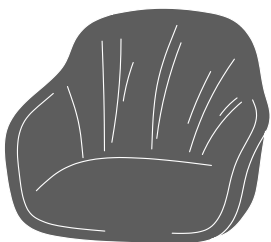

Tessuto cliente: necessaria approvazione di m | artedesign
Fabric supplied by customers: must be approved by m | artedesign



1,8 ml



2,5 mq

COMPATIBILITÀ DEI TESSUTI FABRIC COMPATIBILITY BY COLLECTION

TESSUTI	DILMUN	DILMUN	DILMUN	COMPOSIZIONE COMPOSITION
S	Demetra	●	●	60% POLIESTERE RICICLATO RECYCLED POLYESTER 40% POLIESTERE POLYESTER
	Surround	●	●	87,5% PVC PVC 12,5% COTONE COTTON
	Tonal	●	●	100% POLIESTERE RICICLATO POST-CONSUMO POST-CONSUMER RECYCLED POLYESTER
	Jet	●	●	100% POLIESTERE TREVIRA® CS POLYESTER TREVIRA® CS
A	Mini 	●	●	100% POLIESTERE TREVIRA® CS POLYESTER TREVIRA® CS
	Cura	●	●	100% POLIESTERE RICICLATO POST-CONSUMO POST-CONSUMER RECYCLED POLYESTER
	Guest	○	●	100% POLIESTERE RICICLATO RECYCLED POLYESTER
B	Zenith	●	●	100% POLIESTERE RICICLATO FR RECYCLED POLYESTER FR
	Poseidon	●	●	100% POLIESTERE RICICLATO SEAQUAL® SEAQUAL® RECYCLED POLYESTER
	Gyre	●	●	100% REVIVE PP REVIVE PP
	Fenice	●	●	75% LANA WOOL 25% POLIAMMIDE POLYAMIDE
	Grain	●	●	100% POLIESTERE RICICLABILE RECYCLABLE POLYESTER
	Acton	●	●	87% POLIESTERE RICICLATO FR RECYCLED POLYESTER FR 13% POLIESTERE FR POLYESTER FR
	C	Extrema AU	●	●
Moore		○	●	100% POLIESTERE RICICLATO FR RECYCLED POLYESTER FR
Ally		●	●	95% POLIETILENE TEREFTALATO RICICLATO RECYCLED POLYETHYLENE TEREPHTHALATE 5% POLIESTERE POLYESTER
Focus Melange		●	●	100% LANA NEOZELANDESE NEW ZEALAND WOOL
Bisentium		●	●	30% LANA VERGINE VIRGIN WOOL 28% LANA WOOL 26% POLIAMMIDE POLYAMIDE 16% SETA SILK
Auckland		●	●	76% POLIESTERE RICICLATO FR RECYCLED POLYESTER FR 24% POLIESTERE FR POLYESTER FR
D		Crisp	●	●
	Gorgeus	●	●	100% POLIESTERE TREVIRA® CS POLYESTER TREVIRA® CS
	Breeze Fusion	●	●	88% LANA NEOZELANDESE NEW ZEALAND WOOL 12% POLIAMMIDE POLYAMIDE
	Wolin	●	●	75% LANA RICICLATA POST CONSUMO POST-CONSUMER RECYCLED WOOL 20% POLIESTERE POLYESTER 5% POLIAMMIDE POLYAMIDE
	Remix 3	●	●	90% LANA VERGINE NEW WOOL 10% POLIAMMIDE POLYAMIDE
	E	Rewool	●	●
Canvas 2		●	●	90% LANA VERGINE NEW WOOL 10% POLIAMMIDE POLYAMIDE

TESSUTI	DILMUN			COMPOSIZIONE COMPOSITION
	DILMUN	DILMUN SUPER SOFT Super soft	DILMUN LOUNGE & SOFA	
Encircle	●	●	●	100% POLIESTERE TREVIRA® CS POLYESTER TREVIRA® CS
F Steelcut Trio	●	●	●	90% LANA VERGINE NEW WOOL 10% POLIAMMIDE POLYAMIDE
Hallingdal 65	●	●	●	70% LANA VERGINE NEW WOOL 30% VISCOSA VISCOSE
Ecriture	●	●	●	40% POLIACRILICO POLYACRYLIC 27% POLIESTERE POLYESTER 18% VISCOSA VISCOSE 9% LINO LINEN 6% COTONE COTTON
P Polo	●		●	BOVINO EUROPEO EUROPEAN BOVINE
Q Prescott	●		●	BOVINO EUROPEO EUROPEAN BOVINE
Linea	●		●	BOVINO EUROPEO EUROPEAN BOVINE
Sweet	●		●	BOVINO EUROPEO EUROPEAN BOVINE

● Disponibile Available ○ Previa consultazione Upon consultation

ACCESSORI ACESSORIES



STANDARD STANDARD

Ruota nera Ø65 mm in copolimero rinforzato con fasce di rotolamento morbide; battistrada idoneo per pavimenti normali
Black castor d. 65 mm reinforced copolymer soft treads; suitable for normal floors



STANDARD STANDARD

Ruota bianca Ø65 mm in copolimero rinforzato con fasce di rotolamento morbide; battistrada idoneo per pavimenti normali
White castor d. 65 mm reinforced copolymer soft treads; suitable for normal floors

Imballo 100% riciclabile
100% recyclable packaging



SIMBOLI SYMBOLS



Numero di colli
Number of packages



Pezzi per collo
Pieces per package



Volume in m3
Volume in m3



Peso in kg
Weight in kg



Consumo tessuto (ml)
Fabric consumption (ml)



Consumo pelle (mq)
Leather consumption (mq)



Seduta girevole
Swivel seat



Alzata a gas
Gas lift



Classificazione di Reazione al Fuoco
Fire Reaction Classification
CLASSE 1IM - COD. PN 3822D20D1M00002

